

RAVEN

## SCS SideKick

Turn Your Existing Raven Monitor Into An Injection System!

**RAVEN SideKick Injection Console**  
Mates with Existing 440, 450 or 460 Series Consoles!



### Complete Kits for Existing 440, 450 & 460 Consoles

117-0159-915 Kit w/ SideKick, 5 to 200 oz. per minute, & 24 Gallon Tank \$ 5,864.30

117-0159-916 Same as Above, Less Tank \$ 5,323.50

### Check Valves

333-0011-078	.5 PSI, 3/8" SS (N-Serve)	\$132.60
333-0011-088	1/2", 8 gpm,	\$62.40
333-0011-090	1", 14 gpm	\$95.55
333-0011-091	1", 22 gpm	\$117.00
333-0011-093	2", 70 gpm	\$298.35
333-9000-010	3" SS Mixer	\$1287.00

**List Price**  
**Please Apply Discount**

### Inline Mixers

063-0171-303	1" Mixer	\$172.90
063-0171-300	2" Mixer	\$189.28
063-0159-632	11/4" Mixer	\$169.26

RAVEN

CONTROLS & MONITORS

### Flow Max 110



*Economical Design, Ideally Suited For...*

- Chemical fill plants
- Nurse trucks & tanks
- Sprayer Tanks
- Precise measurement of liquids
- 12 Volt

RAVEN

The Flow Max 110 measures the liquid being pumped from one tank to another. An in-line flowmeter provides a signal to the 110 monitor which displays a readout in gallons. The 110 console is an economical, single product flowmeter that provides the reliable service & quality you have come to expect in other Raven flow control systems. Raven offers a variety of flowmeters which allow the Flow Max 110 to accurately meter a wide range of flow rates and accommodate a variety of plumbing sizes.

**Features Include:** -Quick & easy installation & programming -Weather resistant enclosure -Backlit display / Console Displays -Batch volume -Rate of flow -Total volume -sub volume

Part # 063-0171-357 ..... List \$518.70+

+Desired Flow Meter, See Raven Meters

## METER SYSTEMS

RAVEN

### Flow Max 220

In-Line 2" Digital Meter Kit



200 Gallons Per Minute!

- Counts Gallons Per Minute
- Total Gallons

Part# 063-0172-123

List Price \$997.10

*Great for Filling Sprayer Tanks Accurately!*

### Flow Max 220 Replacement Parts:

Hub Housing, Inlet	107-0171-005	\$39.00
Sensor Housing Assm	063-0172-129	746.00
Inlet Hub/Bearing Assm	321-0000-222	288.60
Rotor	321-0000-221	288.60
Clamp, V-Band	435-3003-032	85.80
O-Ring Large	219-0002-238	7.41
O-Ring, Medium	219-0002-140	3.38
Stud/Bearing Assm.	063-0171-082	63.70
Screw, Thread Forming	310-0002-133	5.60

## Hydraulic Control Valves

RAVEN

063-0172-187	3GPM Hyd Control Valve	\$806.26
063-0172-188	8GPM Hyd Control Valve	806.26
063-0172-189	16GPM Hyd Control Valve	862.68
063-0172-190	30GPM Hyd without Press Comp	862.68
063-0172-191	3GPM Hyd With Fast Motor	824.46
063-0172-192	8GPM Hyd With Fast Motor	824.46
063-0172-193	16GPM Hyd With Fast Motor	824.46
063-0172-194	30GPM Hyd With Fast Motor	824.46
063-0171-841	5GPM PWM Hyd Control Valve	928.20
063-0171-842	10GPM PWM Hyd Control Valve	928.20
063-0171-843	15GPM PWM Hyd Control Valve	928.20
063-0171-846	30GPM PWM Hyd Control Valve	928.20
063-0172-197	30GPM Hyd without Press Comp	806.26
063-0172-844	25GPM Hydraulic Valve	1365.00
063-0172-897	40GPM Hydraulic Valve	1556.10

RAVEN

## REGULATING VALVES



Shown: 894 Valve with 1 1/2" Npt & 1 1/2" Flange (replaces 446 Valve)

063-0171-120	3/4" Poly Valve.....	\$211.12	
063-0172-125	1" Poly Valve Flanged.....	413.14	— Replaces 1" - 4
<b>063-0171-894</b>	<b>1 1/2" Poly Valve flanged.....</b>	<b>460.46</b>	— Replaces 1 1/2"
063-0172-977	1" Carbon Steel NH3.....	766.58	— Replaces 557
063-0172-177	2" S.S. Valve.....	1037.40	— Replaces 805
063-0172-181	3" S.S. Valve.....	1920.10	— Replaces 911
063-0172-978	1" NH3 on/off.....	776.41	— Replaces 500
063-0172-979	1" Fast Close for NH3.....	963.14	— Replaces 155
063-0172-173	1/4" Control Valve, SS Ball.....	709.80	
063-0172-174	1/4" On/Off Valve, SS Ball.....	700.70	

## RAVEN FLOW METERS

List Price Please Apply Disc

**RFM15**  
.3-30 GPM,  
1 1/2" Npt & 1 1/2"  
200 series Flanged



063-0172-040  
\$ 460.46

**RFM55**  
1-55 GPM,  
175 PSI  
1 1/4" Hose Barb **NOT AVAILABLE**



063-0159-571  
\$ N/A

**RFM60P**  
1-66 GPM  
1 1/2" Npt & 1 1/2"  
200 series Flanged



063-0171-793  
\$ 613.34



Old Style

**RFM66A**  
1-66 GPM  
Check Rapid  
NH3 Replaces  
Old Style



063-0171-666  
\$ 972.97

**RFM100**  
3-100 GPM  
2" FPT 220 series Flanged



063-0171-066  
\$ 1001.00

**RFM200**  
15-200 GPM



063-0159-574  
\$ 1501.50

**RFM200P**  
15-200 GPM  
90 PSI



063-0159-751  
\$ 1501.50



**RFM400** 15-200 GPM  
063-0159-966 \$ 2675.40



## Magnetic Flow Meters For Manure & Other Applications

2" Mag Meter	063-0172-682	\$ 2666.30
3" Mag Flow Meter	063-0172-066	\$ 8230.00
4" Mag Flow Meter	063-0171-990	\$ 8230.30
6" Mag Flow Meter	063-0173-027	\$ 9590.75
8" Mag Flow Meter	063-0172-255	\$ 11846.90

## Flow Max 220 In-Line 2" Digital Meter Kit 200 GPM

- Counts Gallons Per Minute
- Total Gallons

Part# 063-0172-123  
List Price \$997.10



Great for Filling  
Sprayer Tanks  
Accurately!

CONTROLS & MONITORS

Injection Controls **RAVEN**

SCS4000 Series

SCS 4400 LIQUID CONTROL SYSTEM

CONTROL CONSOLE  
SCS 440C: 063-0172-281 \$2,730.00

RPR 100S RECEIVER  
063-0172-366

COMPACT FLASH CARD (64 MB):  
524-0002-046

**List Price**  
Please Apply Discount

SPEED EXTENSION CABLES  
10': 115-0171-262 \$112.84  
12': 115-0159-032 \$124.93  
18': 115-0171-239 \$110.83  
24': 115-0159-018 \$137.02  
29': 115-0171-241 \$108.81

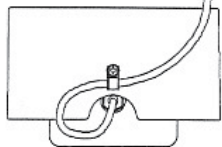

SPEED SENSORS

RADAR (RADAR ONLY): 063-0159-835  
RADAR (KIT WITH POWER CABLE): 063-0159-836

\*\* WIDE VARIETY OF WHEEL DRIVE, SPEEDOMETER AND RADAR ADAPTER CABLING. CONSULT RAVEN SALES REPRESENTATIVE FOR PART NUMBERS \*\*

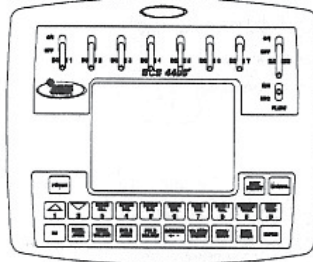

CONSOLE CABLES  
3': 115-0171-299 \$711.30  
15': 115-0171-300 \$838.24

RADAR POWER CABLE  
12': 115-0159-539 \$177.32

CABLE  
115-0171-214  
115-0171-350 (FOR NEW 100 WITH GPS SPEED)

CAN BUS CONNECTION

EXTENSION CABLES  
\$467.48 12': 115-0171-319  
\$584.38 24': 115-0171-320

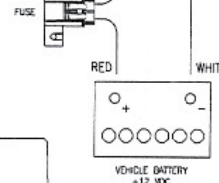

PRODUCT CABLES  
\$519.87 12' 10' BOOM: 115-0171-313  
\$594.43 24' 10' BOOM: 115-0171-314  
\$360.69 12' 5' BOOM: 115-0171-315  
\$403.00 24' 5' BOOM: 115-0171-316

EXTENSION CABLES\*

FLOW EXTENSION CABLES  
6' LONG: 115-0159-016\* \$96.72  
12' LONG: 115-0159-017\* \$100.75  
24' LONG: 115-0159-019\* \$120.90

\* CAN ALSO BE USED FOR PRESSURE SENSOR EXTENSIONS

PRESSURE SENSOR CABLES  
6': 115-0171-235 \$106.80  
12': 115-0171-151 \$114.86  
37': 115-0171-224 \$185.38  
44': 115-0171-296 \$193.44

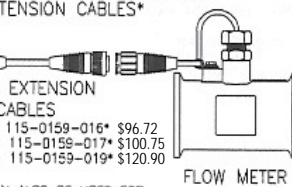

FLOW METER

PRESSURE SENSOR  
422-0000-059  
\$603.20

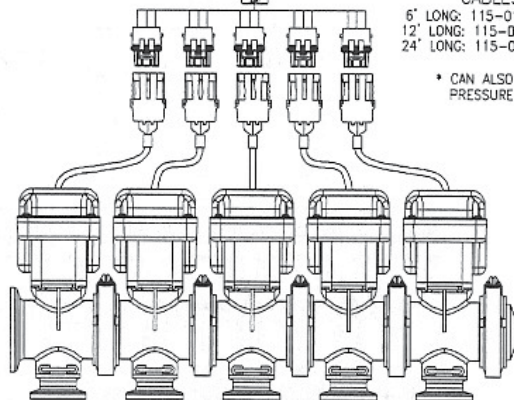

BOOM VALVES

1 SECTION: 063-0171-926  
3 SECTION: 063-0171-928  
5 SECTION: 063-0172-039

CONTROLS & MONITORS



# RAVEN 4000 SERIES CONTROLLERS

RAVEN

## SCS-4400

RAVEN

NEW!!



SCS4400 Controls Up To 3 Products for Injection & Up To 7 Boom Switches.

### SCS4400 Features Include:

- Sprayer Control
- Data Logging
- Easy-to-Read Display
- Ground Speed Compensated Rate Control
- GPS Compatible
- 7 Boom Control
- Low-Limit Function
- Audible Alarms for System Monitoring
- Self-Test Function for Prefield Checkout
- Data-Log as Applied Maps to Flashcard
- 4" VGA Monochrome Display
- 2 Preset Programmable Rates
- Program Data-Logger Through Keypad
- Serial Interface Capabilities

### Sample Kit Pricing:

- 117-0159-924 - Console kit \$ 2848.30
  - 115-0171-299 - 3' console cable \$ 711.30
  - 115-0171-319 - 12' Extension cable \$ 467.48
  - 115-0171-315-12' product cable, 5 Bm \$ 360.69
- Add desired Flow Meter, Control Valve & Speed Sensor Kit

Call to complete a kit for desired application.

## SCS-4000

RAVEN

NEW!!



SCS4000 Controls Up To 3 Products for Injection & Up To 7 Boom Sections May Be Contolled (no Boom Switches in Console).

### SCS4000 Features Include:

- Sprayer Control
- Injection Control Up to Three Products For Canbus System Only (No Datalogging in Console)
- Easy-to-Read Display
- Ground Speed Compensated Rate Control
- GPS Compatible
- 7 Boom Control
- Low-Limit Function
- Audible Alarms for System Monitoring
- Self-Test Function for Prefield Checkout
- 4" VGA Monochrome Display
- 2 Preset Programmable Rates
- Serial Interface Capabilities



RAVEN

## SCS-4600

RAVEN

NEW!!



SCS4000 Controls Up To 3 Products for Injection & Up To 7 Boom Sections May Be Contolled (no Boom Switches in Console).

### SCS4600 Features Include:

- Sprayer Control
- Injection Control Up to Three Products
- Datalogging in Console
- Easy-to-Read Display
- Ground Speed Compensated Rate Control
- GPS Compatible
- 7 Boom Control
- Low-Limit Function
- Audible Alarms for System Monitoring
- Self-Test Function for Prefield Checkout
- 4" VGA Monochrome Display
- 2 Preset Programmable Rates
- Serial Interface Capabilities

### Sample Kit Pricing:

- 117-0159-926 - 4600 Console - \$ 2730.00
  - Add Injection Components From SCS750 Page
  - 115-0171-299 - 3' console cable \$ 711.30
  - 115-0171-319 - 12' Extension cable \$ 467.48
  - 115-0171-315 - 12' product cable, 5 Bm \$ 360.69
- Add desired Flow Meter, Control Valve & Speed Sensor Kit

Call to complete a kit for desired application.

CONTROLS & MONITORS

### Console Kit Pricing:

117-0159-924	Kit, SCS4400, Datalogging, 7 Switches in console	2848.30
117-0159-925	Kit, SCS4000, No Datalogging, No Boom Switches, Canbus Only	1892.80
117-0159-926	Kit, SCS4600, Datalogging, No Boom Switches	2730.00

Add Injection Components From SCS750 Page (Next Page) if Needed

### Components

063-0172-281	Console, SCS4400	\$2730.00
063-0172-320	Console, SCS4000	\$ NA
063-0172-343	Console, SCS4600	\$2666.30

115-0171-299	Cable, 3' Console, 4400	\$711.30
115-0171-300	Cable, 15', Console, 4400	\$838.24
115-0171-313	Cable, 12' product, 10 Boom Liq.4400,4600	\$519.87
115-0171-314	Cable, 24' product, 10 Boom Liq.4400,4600	\$594.43
115-0171-315	Cable, 12' product, 5 Boom Liq.4400,4600	\$360.69
115-0171-316	Cable, 24' product, 5 Boom Liq.4400,4600	\$403.00

### Components

115-0171-317	Cable, 3' Console, 4600	\$658.91
115-0171-318	Cable, 15', Console, 4600	\$763.69
115-0171-319	Cable, 12' Extension, 4400,4600	\$467.48
115-0171-320	Cable, 24' Extension, 4400,4600	\$584.35
115-0171-334	Cable, 3', Console, SCS4000	\$298.22
115-0171-365	Cable, 10', Product, Granular,4400,4600	\$584.35

RAVEN

## SCS 750/760 INJECTION SYSTEM

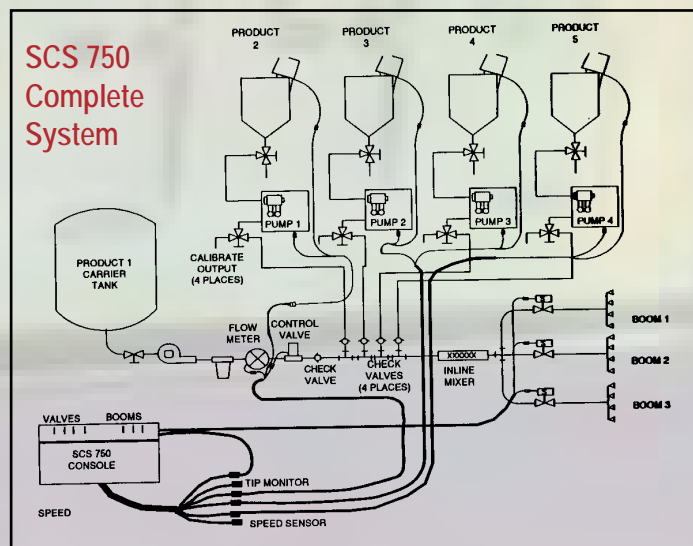

Today's answer for carrier control and direct chemical injection with one console is the SCS750. It is capable of controlling five chemicals or four chemicals and one carrier at one time. The console can also control up to ten boom sections. The SCS 750 features the same user-friendly programming as the SCS 440 and 700 consoles and is compatible with all current raven valves flow meters. Regardless of vehicle speed, the SCS 750 automatically maintains the flow carrier & chemicals. Each of the five control loops has a manual override switch that allows the operator to manually control flow for each chemical and the carrier. Actual rates being applied of the carrier and the chemicals is displayed at all times on the LCD display. Visual and audible alarms warn the operator if he is off the target rate. The SCS 750 also has the standard features of acre counting, speed monitoring, volume totals, and tip monitoring. Plus, all information from these data features can be downloaded into a printer for record-keeping. The SCS 750 console maintains a 10-year memory regardless of power status.

### SCS 750 CHEMICAL INJECTION SYSTEM CAN CONTROL THE CARRIER AND UP TO FOUR SEPARATE CHEMICALS

#### BASE COMPONENTS

Part#	Description	List Price
063-0159-903	SCS 750 Console <b>LIMITED QTY'S</b>	\$ 3878.00
063-0171-837	SCS760 Console, Liquid & Granular <b>LIMITED QTY'S</b>	4210.00
115-0159-561	Console Cable, 3'	552.11
115-0159-562	Product Cable, 21'(1 Cable Required per 2 Products)	604.50
115-0159-563	Boom Cable, 21'	209.56
063-0159-907	Boom Control Box, 5-Boom	431.34
063-0171-303	1" Mixer	172.90
063-0171-300	2" Mixer	189.28
063-0159-632	1 1/4" Mixer	160.17
115-0159-612	12' Product Extension Cable	477.56
115-0159-613	24' Product Extension Cable	574.28



#### Necessary Components for Controlling Carrier (OPTIONAL)

063-0171-793	RFM60P Flow Meter / 1-66 Gpm	613.14
063-0172-125	1" Poly Control Valve, Flanged	413.14
115-0159-456	Control Valve Adapter Cable, 21'	114.86

#### INJECTION ASSEMBLIES

063-0171-012*	Injection Assemblies, High Volume (2.5 to 200 oz. per minute) (Add tank & Saddle)	4836.00
063-0171-013*	Injection Assemblies, low Volume (.5 to 40 oz. per minute) (Add tank & Saddle)	5281.00

\*Add \$479.00 to List Price to Upgrade to Dual Flow Switch Module

#### TANKS

117-0159-537	8 Gallon Poly Tank- <i>Less Injection Module &amp; Saddle Kit</i>	298.48
117-0159-539	16 Gallon Poly Tank- <i>Less Injection Module &amp; Saddle Kit</i>	325.78
117-0159-541	24 Gallon Poly Tank- <i>Less Injection Module &amp; Saddle Kit</i>	364.00
117-0159-___	Saddle Kit, 552= 8gal, 553=16gal or 554=24 Gal. Tank (Only Required for C-5,-6,-7)	222.04

CONTROLS & MONITORS



**List Price**  
Please Apply Discount

## RAVEN Injection Controls

# RAVEN

### SCS 750/760 INJECTION SYSTEM

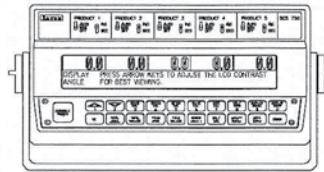

CONTROL CONSOLE  
SCS 750: 063-0159-903  
SCS 760: 063-0171-837

**List Price  
Please Apply Discount**

#### Check Valves

- 333-0011-078 .5 PSI, 3/8" SS (N-Serve) \$ 132.60
- 333-0011-088 1/2", 8 gpm, \$ 62.40
- 333-0011-090 1", 14 gpm \$ 95.55
- 333-0011-091 1", 22 gpm \$ 117.00
- 333-0011-093 2", 70 gpm \$ 298.35

CONSOLE CABLES  
\$552.11 3': 115-0159-561  
\$658.91 12': 115-0159-657

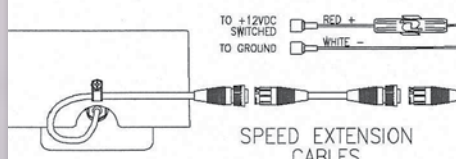
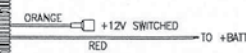

SPEED EXTENSION CABLES  
10': 115-0171-262 \$112.84  
12': 115-0159-032 \$124.93  
18': 115-0171-239 \$110.83  
24': 115-0159-018 \$137.02  
29': 115-0171-241 \$108.81

SPEED SENSOR  
RADAR: 063-0159-836  
CONTAINS RADAR AND POWER CABLE 115-0159-539)

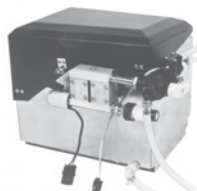

PRODUCT EXTENSION CABLES  
12': 115-0159-612 \$477.56  
24': 115-0159-613 \$574.28

PRODUCT CABLES  
21': 115-0159-562 \$604.50  
21': 115-0159-985 \$425.17 (SINGLE PRODUCT)  
21': 115-0171-012 \$457.41 (DUAL FLOW METER)

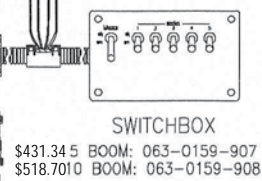

SWITCHBOX  
\$431.34 5 BOOM: 063-0159-907  
\$518.70 10 BOOM: 063-0159-908

BOOM EXTENSION CABLES  
12': 115-0159-614 \$108.81  
24': 115-0159-615 \$145.08

BOOM CABLE  
21': 115-0171-213 \$435.24

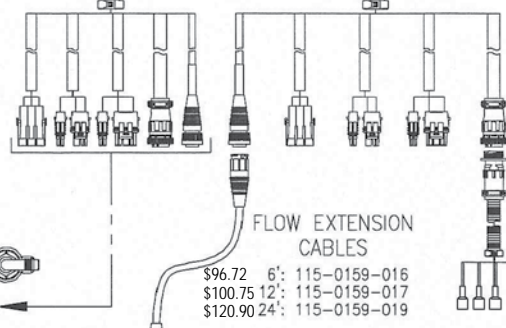

FLOW EXTENSION CABLES  
\$96.72 6': 115-0159-016  
\$100.75 12': 115-0159-017  
\$120.90 24': 115-0159-019

ADAPTER CABLE  
115-0159-456

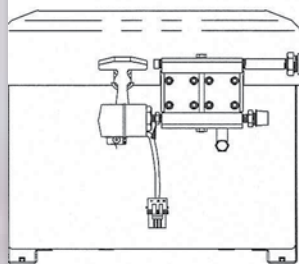

INJECTION MODULES  
HIGH VOLUME: 063-0171-012  
LOW VOLUME: 063-0171-013

FLOW METER

CONTROL VALVE

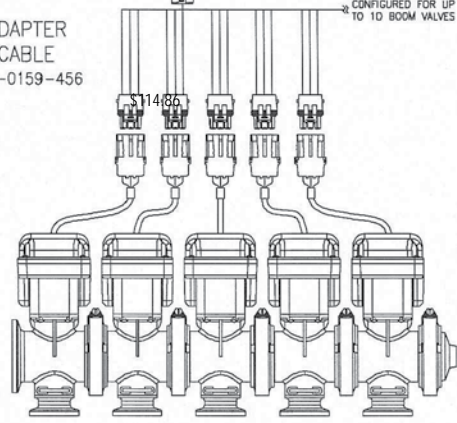

BOOM VALVES  
1 SECTION: 063-0171-926  
3 SECTION: 063-0171-928  
5 SECTION: 063-0172-039

**CONTROLS & MONITORS**